

Article number: 20472221V

Description: E+G Handwheel  
GN 213-50-V 12

## Measures

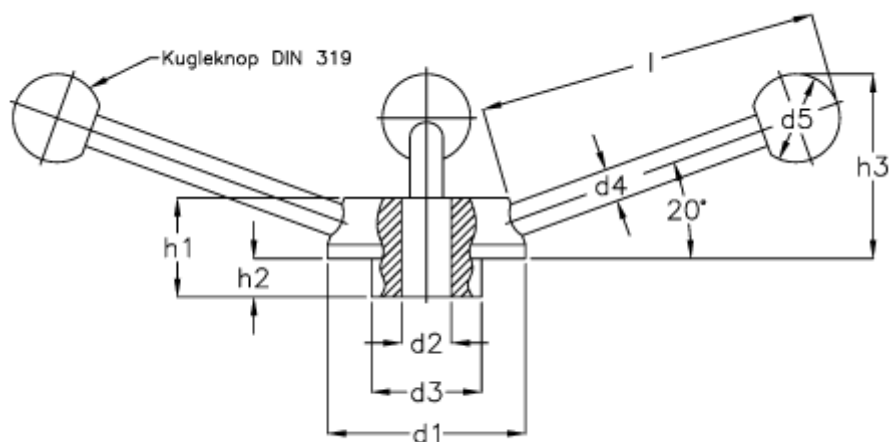

$d1 = 50$   
 $d2 = B 12$   
 $d3 = 28$   
 $d4 = 8$   
 $d5 = 20$   
 $H1 = 26$   
 $H2 = 9$   
 $l = 82$